

User Manual

 МУЗЦЕНТР
МУЗЫКАЛЬНОЕ ОБОРУДОВАНИЕ

<https://muzcentre.ru>

JBA35 **BASS AMPLIFIER**



 **JOYO**

JOYO TECHNOLOGY CO., LTD

BASS AMPLIFIER

INTRODUCTION

We know you don't like reading owners manuals, but you've just purchased one of the finest bass amplifiers around, and we want to tell you about it! So, before you plug in and start popping and slapping, we'd like to suggest you take just a few moments out to scan these pages.

The JBA35 is powerful combo amplifiers, which include a matched 8-ohm aluminum bass speaker in a specially designed cabinet which can be used either flat on the floor or on its "kickback" position for increased high end clarity on directionality. It's the perfect system for use in small venues such as club dates and for home recording studios. Plus, the CD input and dedicated headphone output makes them awesome practice amps!

JBA35 got a 35-watt amp and a "10" custom design Aluminum Series speaker. When you purchased this JBA35, you're assured of that great JOYO sound system.

In these pages, you'll find a detailed description of the many features of your JBA35 Combo Bass Amplifier, as well as a guided tour through its front and rear panels, step-by-step instructions for setting up and using the amp. Additional, please try to check out our website www.joyoaudio.com for complete information about our full product line.

SPECIAL NOTE: Should your JBA35 Combo Bass Amplifier ever require servicing, a Return Authorization (RA) number is necessary. Without this number, the unit will not be accepted. Please retain the original packing materials and, call JOYO 0755-29765393 before you sending out if possible, return the unit in its original carton and packing materials.



INSTRUCTIONS PERTAINING TO A RISK OF FIRE, ELECTRIC SHOCK, OR INJURY TO PERSONS.



The lightning flash with arrowhead symbol, within an equilateral triangle, is intended to alert the user to the presence of uninsulated "dangerous voltage" within the product's enclosure that may be of sufficient magnitude to constitute a risk of electric shock to persons.



The exclamation point within an equilateral triangle is intended to alert the user to the presence of important operating and maintenance (servicing) instructions in the literature accompanying the product.

IMPORTANT NOTES

- Please read all instructions before operating the unit.
- Keep these instructions for future reference.
- Please heed all safety warnings.
- Follow manufacturers instructions.
- Do not use this unit near water or moisture.
- Clean only with a damp cloth.
- Do not block any of the ventilation openings. Install in accordance with the manufacturers instructions.
- Do not install near any heat sources such as radiators, heat registers, stoves, or other apparatus that produce heat.
- Please use matched polarized or grounding-type plug, the wide blade or third prong is provided for your safety. When the provided plug does not fit your outlet, consult an electrician for replacement of the obsolete outlet.
- Protect the power cord from being walked on and pinched particularly at plugs, convenience receptacles and at the point at which they exit from the unit.
- Unplug this unit during lightning storms or when unused for long periods of time.
- Refer to qualified personnel when the unit has been damaged in any way.

JBA35 COMBO BASS AMPLIFIER FEATURES

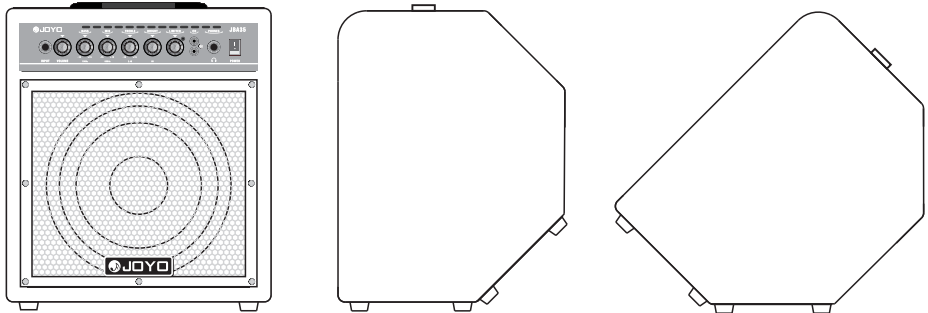

The JBA35 offers all the newest concepts in state-of-the-art aluminum drive bass amplification in an extremely compact size and affordable price. Here are some of its main features:

- The 35 Watts of power to its specially designed 10-inch aluminum bass driver.
- Specially designed cabinet which can be used either flat on the floor or on its "kickback" position for increased high end clarity on directionality.
- Bipolar circuit design ensures that every nuance of your bass performance is reproduced faithfully.
- Flexible input that accommodates a broad range of input levels, so that you can use the JBA35 with pretty much any kind of bass, from passive models to those with active circuitry. It is almost impossible to overload the input of a JBA35 bass amplifier!
- Four bands of high-quality equalization, allowing you to create a broad range of tonal colors for your bass instrument.
- Preamp Out and Amp In jacks that allow you to connect to professional outboard effects processors.
- A dedicated CD input is included allowing you to hook up a portable CD or MP3 player or other sound sources to practice along with.
- A separate headphone output, which automatically disconnects the speaker output allowing use as a high-quality practice amp.
- For interfacing with PA systems or recording mixing consoles, an XLR line-level direct output is included on the rear panel.
- Included is a matched JOYO 8-ohm speaker mounted in a specially designed cabinet for clean, crisp sound.
- Rugged construction makes the JBA35 eminently road-worthy.

BASS AMPLIFIER

GUIDED TOUR - FRONT PANEL

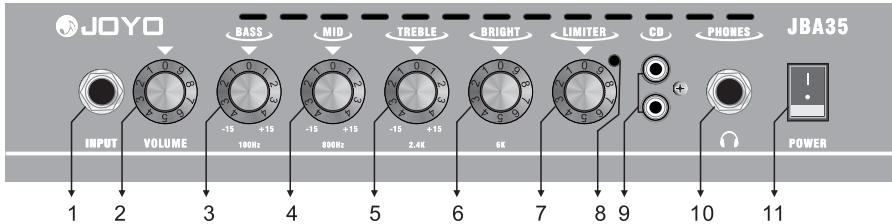

1. **Input** – Connect your bass guitar to this standard 1/4" unbalanced jack. The JBA35 is designed to handle low-level signals if your bass has passive electronics (that is, if it has no battery), or the signals from hotter bass pickups if your bass has active electronics (that is, if it has a battery).
2. **Volume control** – This is the overall volume control. For best signal-to-noise ratio, keep the output of your bass at or near maximum and adjust the Volume to the desired level.
3. **Bass EQ control** – This control provides approximately 15 dB of cut or boost at 100 Hz, with a peak (bell) curve. When the knob is at the triangle "0" position (at a sticking point), there is no boost or attenuation. As it is turned clockwise to the +15 position, the frequency area is boosted; as it is turned counterclockwise from the -15 position, the frequency area is attenuated.
4. **Mid EQ control** – This control provides approximately 15 dB of cut or boost at 800 Hz, with a peak (bell) curve. When the knob is at the triangle "0" position (at a sticking point), there is no boost or attenuation. As it is turned clockwise to the +15 position, the frequency area is boosted; as it is turned counterclockwise from the -15 position, the frequency area is attenuated.
5. **Treble EQ control** – This peaking control provides approximately 15 dB of cut or boost at 2.4 kHz. When the knob is at the triangle "0" position (at a sticking point), there is no boost or attenuation. As it is turned clockwise to the +15 position, the frequency area is boosted; as it is turned counterclockwise from the -15 position, the frequency area is attenuated.
6. **Bright** – This control provides approximately 20 db of boost at 8 kHz, with a peak (bell) curve. When the knob is at the triangle "0" position, there is no boost or attenuation. As it is turned to maximum, the frequency area is boosted.
7. **Limiter Control** – This determines the amount of compression (peak signal reduction) by simultaneously adjusting both threshold and compression ratio which ranges from 2:1 to infinity [limiting]. At the triangle turn counterclockwise from "Zero" position, the circuitry is bypassed and no compression is applied. As the knob is raised clockwise (at settings from "0" to maximum, increasing amounts of compression are applied.
8. **Limiter LED** – Light out, no compression is being applied. When flashing or light up, limiter start to work, the amount is decided by limiter.
9. **CD Input** – JBA35 amplifier features a CD input which you can use with a portable CD player, cassette, mini disk or MP3 player. You can use the CD input to jam with pre-recorded tracks or to learn a riff from a favorite recording.
10. **Phone jack** – Connect any stereo headphone (600 ohms or less) to this standard 1/4" stereo jack. When a plug is inserted into the headphone jack, the speaker output is disconnected, allowing you to use your JBA35 as a practice amplifier. The level of the signal sent to the headphones is determined by the setting of the Volume knob. Recover speaker output by pull out stereo headphone.
11. **Power switch** – Turn on power switch, LED is up, operate normally after 5seconds.

GUIDED TOUR - REAR PANEL

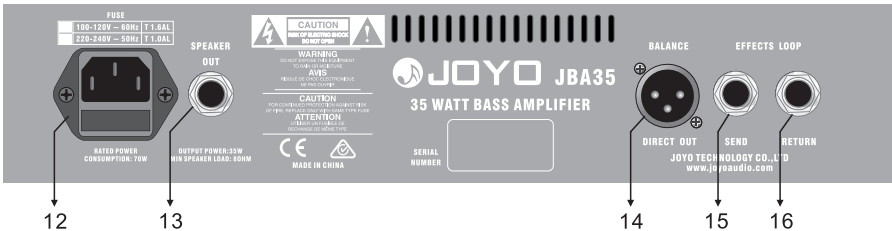

12. **AC Power Inlet** - Use the supplied grounded AC power cord to connect your JBA35 amplifier to mains power. This cord comes supplied with the appropriate plug for your geographic area. Do not use an adapter to defeat the third grounding pin on this plug or severe electric shock may result!
13. **Speaker Output** - The jack is used to connect the internal 8-ohm aluminum driver.

- 14. Direct Output** – This standard, balanced XLR connector provides a Line-level output signal from the JBA35 amplifier. You'll usually use this to connect the JBA35 signal to a Line-level input when interfacing with PA systems or recording mixing consoles.
- 15. Preamp Out (Effects Loop Send)** – Use this 1/4" unbalanced jack to send signal to a professional outboard effects processor. Output after equalized, output level is approximately 0 dB to +2 dB.
- 16. Amp In (Effects Loop Return)** – Use this 1/4" unbalanced jack to return signal from a professional outboard effects processor.

SETTING UP AND USING YOUR JBA35 COMBO BASS AMPLIFIER

Setting up your JBA35 Combo Bass Amplifier is a simple procedure which takes only a few minutes:

- Remove all packing materials (save them in case of need for future service) and decide where the amplifier is to be physically placed. You may decide to use the "kickback" position for additional directionality and high frequency clarity. To avoid potential overheating problems, make sure that the rear panel is unobstructed and that there is good ventilation around the entire unit.
- Before you plug-in the power cable, be sure the Power switch is in the off position. Connect the supplied power cable to the AC inlet located on the rear panel. Then, plug-in the 3-pin AC plug into any grounded AC socket. Don't turn the JBA on just yet, though.
- Use a standard music instrument cable to connect your bass to the Input jack on the front panel. The JBA Input has been designed to handle the signal from most any bass guitar. So, whether your bass has passive electronics or active electronics, plug right in.
- On the front panel, turn counterclockwise the Volume, Bright and Limiter control to triangle position "0", and turn position "0" of Bass, Mid and Treble to triangle position (at a sticking point).
- Press the front panel Power switch; the LED in the switch will light up, the unit starts to work.
- Set the output of your bass to maximum and then, while playing, slowly turn the Volume control up until the desired level is achieved. It's nearly impossible to overload the JBA35 amplifier, so if you hear distortion even at low Volume settings, check for a faulty cable.

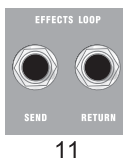
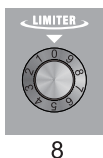
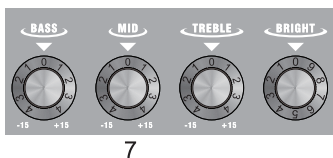
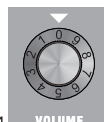

- Adjust the four equalization controls to taste. When you get a great setting that complements your instrument and playing style, it's a good idea to write it down for future use.
- Now try out limiter circuitry. Activate it by turning the Limiter knob clockwise from its "Triangle" position. The input signal from your bass becomes more and more severely compressed—you'll hear peak signals begin to sound increasingly "squashed," relative to the lower-level signals produced by standard playing. The result will be a decreased dynamic range but an overall leveling of signal throughout the full pitch range of your instrument. The Limiter LED will light steadily blue when no compression is being applied, will flash or light steadily blue when limiting (severe compression) is being applied.
- Turn the Volume control to its minimum (fully counterclockwise) position and then connect a standard stereo headphone to the front-panel Phones jack. While playing your bass, slowly turn the Volume control up—you should hear sound from the headphones and none from the connected speaker. We recommend the use of large size headphones (those with large transducers) for optimum bass reproduction.
- If you need to connect the JBA to a PA system or a recording mixing console, connect a cable between the rear-panel Direct Out output and a Line-level input on the mixer.
- If you're using a professional external signal processor that has Line-level inputs and outputs, turn your amp off momentarily and then connect a standard audio cable between the rear panel Preamp Out jack and your effects processor input and another standard audio cable between the Amp In jack and your effects processor output. Then turn the JBA35 amp back on and play your bass while adjusting the controls of your effects processor(s). For best results, set both the input and output gain of the connected effects processor(s) to 0 dB, so that there is no increase or decrease in level whether the effects are switched in or out.
- If you encounter difficulty with any aspect of setting up or using your JBA35 Bass Combo Amplifier, you can call JOYO (0755-29765393) between 9 AM and 5 PM, or contact your local distributor.

USING THE CD INPUT:

Your JBA35 amplifier features a CD input which you can use with a portable CD player, cassette, mini disk or MP3 player to jam with pre-recorded tracks or learn a riff from a favorite tune. In fact, you can plug any line level signal into the CD input including the signal from a keyboard or drum machine. Connect the CD player or other Line level device to the CD Input using standard RCA cable. You will want to use the volume control on the CD player or other Line level device to set the balance between the track and your bass. So, start with the volume control all the way down and slowly raise it until you reach a good balance with your bass.



USING EQUALIZATION:

1. The JBA35 Bass Amplifier gives you enormous control over shaping the sound of your bass, using a process called equalization. To understand how this works, it's important to know that every naturally occurring sound consists of a broad range of pitches, or frequencies, combined together in a unique way. This blend is what gives every sound its distinctive tonal color. The JBA EQ controls allow you to alter a sound by boosting or attenuating specific frequency areas—they operate much like the bass and treble controls on your hi-fi amp, but with much greater precision.
2. Four bands of equalization, each EQ knob labeled Bass, Mid, Treble and Bright, respectively affects a different frequency area 100 Hz, 800 Hz, 5 kHz and 8 kHz, respectively and provides approximately 15 dB of boost and attenuation except for the Bright control which provides 0 -20 dB of Boost only. We carefully selected these frequency areas because they have maximum impact on bass signals.
3. When an EQ knob is in its center triangle position "0" (at a sticking point), it is having no effect. When it is moved right of center, the particular frequency area is being boosted; when it is moved left of center, the frequency area is being attenuated.
4. In many instances, the best way to deal with equalization is to think in terms of which frequency areas you need to attenuate, as opposed to which ones you need to boost. Be aware that boosting a frequency area also has the effect of boosting the overall signal; specifically, too much Low EQ boost can actually cause overload distortion or even harm the connected speaker.

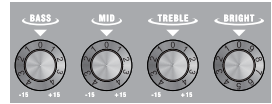

SPECIFICATIONS

1. Rated Output Power (@ 1 kHz, 8 ohm, 1% THD)	35W
2. Rated Input Level (@ 1 kHz)	-20 dBu
3. Total Harmonic Distortion (@ 1 dB below rated output, 1 kHz typical)	0.3%
4. Signal To Noise Ratio (re: 1 Wrms @ 1 kHz)	62 dB
5. Dynamic Range (re: Rated output @ 1 kHz)	71 dB
6. Signal Gain	
Input to Direct Out	-20 dB
Input to Preamp Out	+20 dB
Input to Speaker Out	+46 dB
7. Equalizer	
Bass (100 Hz)	±15 dB
Mid (800 Hz)	±15 dB
Treble (2.4 kHz)	±15 dB
Bright (6 kHz)	0-20 dB
8. Headphone Output	200 mW (typical) @ 600 ohms
9. Fuse Type	Slow-blow fuse
10. Fuse Rating	
100-120V~60Hz	T1.6AL
220-240V~50Hz	T1.0AL
11. Weight	15.7 kg
12. Dimensions	373(L) x 318 (W) x426(H) mm



JOYO TECHNOLOGY CO., LTD

Address: 2/F, Lushi Industry Building, 28th District, Bao'an, Shenzhen, 518101 China.

www.joyoaudio.com Email:info@joyoaudio.com Tel: 0086-755-29765381

35瓦特贝司功放
用户使用说明

JBA35
BASS
AMPLIFIER



深圳市卓乐科技有限公司

感谢您购买我们的产品!

我们知道你不喜欢阅读所有的手册，但您刚买一台如此好的贝司功率放大器，我们想让您了解它！所以在你插上电源并开始享受音乐之前，我们建议您稍花一点时间大致浏览以下这些内容。

功能强大的JBA35组合功率放大器，专门设计的机箱和机内包含一个匹配的8Ω 铝贝司喇叭，这个机箱能在平面或斜面增强高清晰指向性反冲位置上使用。在小场所诸如：俱乐部和家庭或工作室中使用，这将是一款完美的系统。CD输入和耳机输出功能成为十分出色的实用性功率放大器。

JBA35贝司功率放大器拥有四种模式，35W的功率和一个10英寸JOYO铝系列喇叭。当你购买了JBA35贝司功率放大器，您将拥有JOYO强大完美的贝司音响系统。

在这些说明中，您将发现JBA35组合贝司功率放大器有很多特征的描述，也有前后控制板上的操作指示，一步一步的设置和使用操作。如果需要了解我们的新产品，请登陆我们的网站“www.joyochina.cn”上了解我们的全部产品信息。

特别提示：如果您的JBA35组合贝司功率放大器需要维修时，则需要归还授权(RA)号码，若没有这一号码，这个设备将不接受维修。请保持原包装材料一起寄出，在寄出维修之前，请拨打JOYO电话0755-29765393取得联系。

重要的安全说明



注意：

机内无用户可用备件！为了防止触电，切勿自行拆开机盖！必要时需由专业人士维修！

警告：

为防止发生火灾或触电危险，本机切勿受雨淋或受潮！



等边三角形中自带的闪电型箭头，该符号用来告诫用户---机内具有危险电压的非绝缘部分，易造成电击的危险。



等边三角形中自带的感叹号，该符号用来提醒用户---机器附件中有重要的操作和保养说明，请查阅使用说明书。

注意事项 ▲

请阅读使用说明书。

- 在使用设备前，请阅读所有的说明。
- 以后的使用中，请参照这些说明。
- 请注意所有的安全警示。
- 按照制造商说明。
- 勿在靠近水源或潮湿处使用此设备。
- 只允许用干布清洁设备。
- 勿掩盖任何通风口，安装时请按照制造商说明。
- 请勿靠近任何热源，如散热器，储热器，炉灶或其它产生热量的设备。
- 请用配套的三脚电源线，三脚电源线是为您的安全而设计的，当这些插头不能用于插座时，请咨询电工更换。
- 请保护好电源线不被踩踏，从设备出来的地方不被挤压。
- 在雷电暴雨或长期不使用设备时，请拔去电源插头。
- 设备损坏时请找专业人士维修。

JBA35组合贝司功率放大器特性

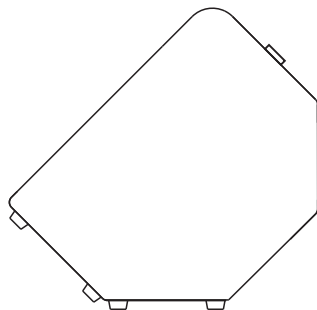
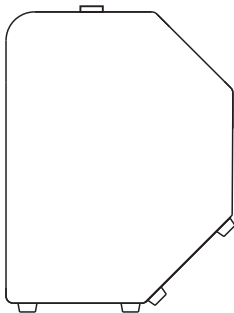
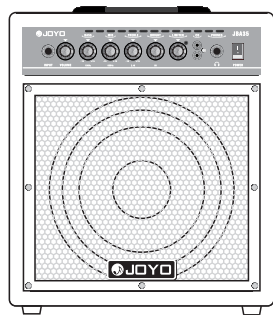

JBA35通过小巧的外型和优惠的价格，提供了所有艺术表现中的新概念铝驱动贝司功率放大器，其主要特性：

- 特制的10英寸铝贝司驱动35W功率。
- 专门设计的机箱使机器能在平地上或斜面上增强高清晰指向性的反冲位置上使用。
- 为确保贝司演奏中每一细微之处都能得到如实的再现，为此特别设计了双极性电路。
- 灵活的输入能适应大范围的输入电平，使得JBA35能适用于几乎所有贝司，从无源模式到有源模式，JBA35贝司功率放大器的超载问题几乎是不可能。
- 四段高品质均衡器，能使您的贝司乐器创造大范围的音色。
- 前级输出和环回输入接口让您能体验专业的效果处理器。
- 专门的CD输入接口，让您能接一个便携式的CD或MP3播放器，或其它的音源来做练习。
- 独立的耳机输出接口，能自动断开喇叭输出，成为高品质的练习功率放大器。
- 后控制板中有一个平衡输出接口，使其能和PA系统或录音混合控制台的相互使用。
- 为追求清脆声音，在特制的机箱中安装了一个相互匹配的JOYO 8Ω 铝贝司喇叭。
- 坚固的构造和小巧的外型，使得JBA35功率放大器特别适合外带。

面板描述

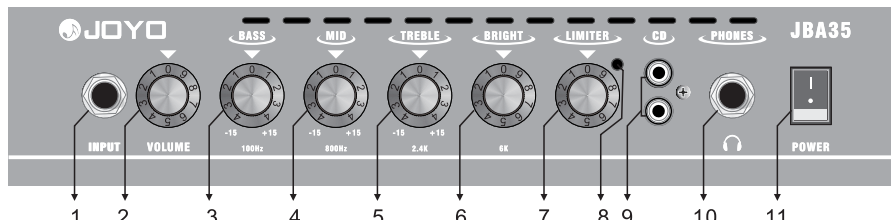

- 1. 输入插口**—将您的贝司连接到1/4英寸不平衡插口，JBA35功率放大器的输入装置为处理低微信号而设计，低微信号来自您的无源贝司，或者是来自您的有源贝司的拾音设备。
- 2. 音量控制器**—这是总音量控制，为了信号与噪音的最好比例，让您的贝司输出处于或接近于最大音量，然后调节到想要的音色位置上。
- 3. 低音控制器**—利用最高曲线提供大约15dB增益和100Hz频率。当旋钮“0”处于中间三角号位置上（有卡点），将没有增益或衰减。按顺时针调至+15时，频率将增强。按逆时针调至-15时，频率将衰减。
- 4. 中音控制器**—利用最高曲线提供大约15dB增益和800Hz频率。当旋钮“0”处于中间三角号位置上（有卡点），将没有增益或衰减。按顺时针调至+15时，频率将增强。按逆时针调至-15时，频率将衰减。
- 5. 高音控制器**—利用最高曲线提供大约15dB增益和2.4kHz频率。当旋钮“0”处于中间三角号位置上（有卡点），将没有增益或衰减。按顺时针调至+15时，频率将增强。按逆时针调至-15时，频率将衰减。
- 6. 明亮控制器**—利用最高曲线提供大约20dB增益和6kHz频率。当旋钮“0”处于中间三角号位置上，将没有增益或衰减。按顺时针调至最大时，频率将增强。
- 7. 限制器控制**—通过同时调节阀值和压缩，例如从2:1到无限大来决定压缩值。在逆时针方向旋钮“0”调至三角号位置上，电路直接通过而且没有经过压缩。按顺时针方向旋钮“0”调至最大时，压缩值将逐渐增大。
- 8. 限制器指示灯**—当指示灯不亮时，信号无压缩。当指示灯闪烁或点亮时限制器开始工作，限制的大小视限制器控制决定。
- 9. CD输入**—JBA35功率放大器带有CD输入接口，这个接口可以连接CD播放器，卡带机，影碟机或MP3播放器一起使用，利用CD输入接口预设好的音乐或喜欢的唱片来重复学习。
- 10. 耳机插座**—标准的1/4英寸立体声插口，用于连接立体声耳机（小于600Ω）。当插头插入耳机插口时，喇叭输出将被断开，使您的JBA35功率放大器用做练习功能。输出到耳机上的信号电平大小由音量控制调节决定。拔出立体声耳机时，恢复喇叭输出功能。
- 11. 电源开关**—把电源开关打开，LED灯点亮，5秒钟内整机正常工作。

背板

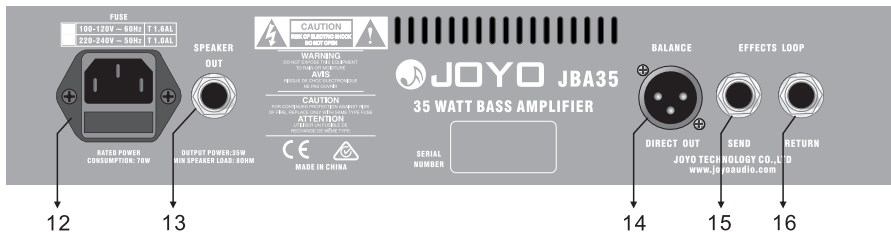

- 12. 交流电输入接口**—使用配套的电源线连接本设备，电源线要适合本地的插头和本地的电压。请勿损坏电源线插头中的接地脚，否则将可能导致严重的电击。
- 13. 喇叭输出插口**—连接木箱内置8Ω铝贝司喇叭。

14. **直接输出插口**-标准平衡输出接口, JBA35功率放大器提供一个直接电平输出信号, 当与PA系统或混合控制设备相互使用时, 通常能用JBA35功率放大器的直接电平输出接口连接到其它设备。
15. **前置放大器输出**-1/4英寸不平衡输出接口, 专业的外部效果处理器输出信号, 均衡后输出, 电平0dBu到+2dBu。
16. **环回输入接口**-1/4英寸不平衡输入接口, 专业外部效果处理器信号输入。

JBA35组合贝司功率放大器的设置与使用

JBA35组合贝司功率放大器的设置很简单, 只需要您几分钟时间:

1. 拆开所有包装(将它们保留好以备日后的维修时使用), 然后选择要将设备放在什么地方, 您可以选择利用反冲位置来得到额外的方向性, 而且使整个设备可以防止很好的过热问题, 请确保后控制板的通风, 而在您插入电源线之前, 请确保电源开关处于关闭状态, 用配套的电源线连接位于后控制板的交流电源输入插口, 然后把三脚电源插头插入电源插座, 这时还不能打开机器。
2. 使用标准的乐器连接线将您的贝司连接到前控制板上的输入插口, 大部份的贝司都可以使用这个设备的接口。所以, 不管您的贝司是无源还是有源的, 都可以从这里输入。
3. 在设备的前控制板上, 按逆时针方向将音量控制器, 明亮控制器和限制器的旋钮“0”调至三角号位置上(有卡点)。
4. 打开前面控制板上的电源开关, LED灯点亮, 设备开始工作。
5. 将低音控制器调到最大位置上, 然后一边演奏一边慢慢调大音量控制器的旋钮, 当您听到失真, 请检查连接线是否连接错误。

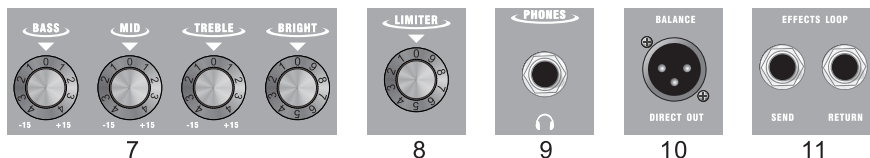
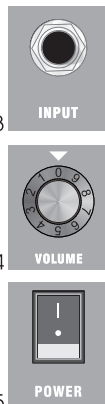

7. 调整四个均衡控制旋钮来测试, 当您调节到适合您乐器和演奏风格的时候, 不妨记下来以备下次使用。
8. 测试限制电路, 从三角号位置上按顺时针方向调限制器, 您的贝司输入信号变的越来越被压缩, 您将听到的是峰值信号, 开始感觉到被压缩, 同时也降低了动态范围, 但总体信号是平稳的。当没有被压缩时, 限制器蓝色灯是不亮的, 当被压缩或最大的时候蓝色灯闪烁或长亮。
9. 测试耳机输出功能, 按逆时针方向调节音量控制器至最小位置上, 将标准立体声耳机连接到耳机插口上, 一边演奏贝司一边慢慢调大音量, 当您听到耳机发出声音的时候, 箱体喇叭没有任何声音。我们建议您使用大耳机(带在头上的那种耳机), 使贝司演奏达到最佳效果。
10. 如果您需要将设备连接到PA系统或调音台, 用一条音频线将后面控制板直接输出与调音台上直接电平输入相连接。
11. 如果你正在使用拥有直接电平输入和输出功能的专业外置信号处理器, 请马上关掉这些功能, 然后用标准音频线连接到后面控制板上的前置放大器输出接口和您的效果器输入接口相连接。另外一根标准音频线连接到效果环回输入接口和您的效果处理器输出接口相连接。然后打开功能, 一边弹奏贝司一边调节效果控制器, 使效果达到最佳状态。为了更好的效果, 设备的输入与输出均设置为0dB。这样效果器开与关的电平都没有增减。
12. 如果你对JOYO JBA35贝司组合功率放大器功能设置或使用方面遇到困难, 请在早上9点至下午5点之间, 你可以致电JOYO寻求技术支持(0755-29765393)或联系您当地的代理商。

CD输入功能使用:

JBA35功率放大器带有一个CD输入装置, 这个装置让您能使用便携CD播放器, 卡带播放器, 影碟机或MP3播放器, 你可以使用这个CD输入插口预设好频道音乐或者喜欢的唱片来重复学习。事实上, 你可以输入任何直接电平信号到CD输入装置, 包括来自电子琴或鼓乐器的信号, 利用标准的RCA线来连接CD播放器或其它直接电平装置, 要想CD播放器或其它直接电平信号上的音量控制设定与贝司之间的平衡, 任何时候都要先从最小音量开始, 然后慢慢加大音量, 直到和贝司达到很好的平衡。



均衡器的使用:

- JBA35贝司放大器均衡器, 使您对贝司声音形成很好的控制, 为了理解它是怎么工作的, 每一组的音域范围或频率自然发出的声音, 这一独特的方式结合将很重要, 这种混合就是给予每一种声音和与众不同的音色。这款机器的均衡控制器引起您注意对特定频率面积的增加或减少, 他们的操作跟贝司和高保真放大器的高音控制很相像, 但精确度会更高。
- 四段均衡器每一个旋钮分别标有Bass, Mid, Treble和Bright, 作用与不同的频率分别标有100Hz, 800Hz, 2.4kHz和6kHz。除了明亮控制只提供0-20dB增益外, 其它的提供15dB的增益和衰减。我们精心选择这些频率, 因为对贝司信号有很大的影响。
- 当均衡器的旋钮“0”在三角号位置上即中间时(有卡点), 均衡器没有效果, 当它从中间向右钮动时, 特定的频率范围开始增强。当从中间向左钮动时, 频率范围开始减弱。
- 很多情况下, 处理均衡器最好的方法是要考虑哪种情况下频率需要减弱, 相反哪种情况下频率需要增强。请记住, 增强某一个频率的同时, 会对总体的信号产生影响, 特别要说的, 太多的低音均衡器增强实际上会使喇叭产生过载或损坏。

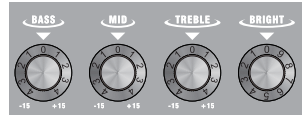

技术数据

- | | |
|-----------------------------------|-----------------------------|
| 1. 额定输出功率: (1 kHz, 8 ohm, 1% THD) | 35W |
| 2. 额定输入电平: (1 kHz) | -20 dBu |
| 3. 总谐波失真: (1 dB, 1 kHz) | 0.3% |
| 4. 信号噪声比: (1 Wrms @ 1 kHz) | 62 dB |
| 5. 动态范围: (Rated output @ 1 kHz) | 71 dB |
| 6. 信号增益 | |
| 输入到直接输出 | -20 dB |
| 输入到前置输出 | +20 dB |
| 输入到喇叭输出 | +46 dB |
| 7. 均衡器 | |
| 低音(100 Hz) | ±15 dB |
| 中音(800 Hz) | ±15 dB |
| 高音(2.4 kHz) | ±15 dB |
| 明亮(6 kHz) | 0-20 dB |
| 8. 耳机输出 | 200 mW (typical) @ 600 ohms |
| 9. 保险丝类型 | 慢熔断保险丝 |
| 10. 保险丝额定值 | |
| 100-120V~60Hz | T1.6AL |
| 220-240V~50Hz | T1.0AL |
| 11. 重量 | 15.7 kg |
| 12. 尺寸 | 373(长) x 318(宽) x 426(高)mm |



深圳市卓乐科技有限公司

公司地址: 深圳市宝安28区陆氏大厦2楼 邮编:518133

www.joyochina.cn

传 真: 0755-29765389 国内销售热线.: 0755-29765116
售后服务邮箱: ele@joyochina.cn 售后服务热线: 0755-29765393